



www.starmakina.com.tr

SC 20 B - SC 20 E
SC 35 B - SC 35 E
SC 431 B - SC 431 E

Yer yıkama makinası
(Floor Cleaning machine)



Kullanım Kılavuzu

(Manuel Users)



SAFETY PRECAUTIONS

This machine is intended for commercial use. It is constructed for use in an indoor environment and is Not intended for any other use. Use only with recommended accessories.

All operators shall read, understand and exercise the following safety precautions:

1) DO NOT OPERATE MACHINE:

Unless trained and authorized.
 Unless you have read and understand the operators manual. In flammable or explosive areas.
 If not in proper operating condition. In outdoor areas.

2) BEFORE OPERATING MACHINE:

Make sure all safety devices are in place and operate properly.

3) WHEN USING MACHINE:

Go slow on inclines and slippery surfaces.
 Follow all safety guidelines.
 Be very careful when using the machine in reverse.
 Report and fix any damage to machine prior to operating it.

4) BEFORE LEAVING OR SERVICING MACHINE:



Stop machine on level ground.
 Turn machine off.

5) WHEN SERVICING MACHINE:

Read operators manual thoroughly prior to operating or servicing this machine. Use manufacturer supplied or approved replacement parts.
 Secure machine with wheel blocks prior to jacking the machine up. Use approved jack or hoist to safely elevate the machine.

WHEN SERVICING MACHINE:(con't)

Disconnect batteries prior to working on machine. Wear gloves when handling batteries or battery cables. Avoid any contact with battery acid.
 Avoid moving parts, Do not wear loose fitting clothing while servicing machine.

	<p>WARNING! Batteries emit hydrogen gas. Explosion or fire can result from hydrogen gas. Keep Sparks and open flames away! Keep battery compartment open when charging.</p>
	<p>WARNING! Flammable materials can cause an explosion or fire. Do not use flammable materials In tanks.</p>
	<p>WARNING! Flammable materials or reactive metals can cause explosion or fire. Do not pick up.</p>

MACHINE SET UP&INSTALLATION**UNCRATING MACHINE**

Be sure and check packing carton for any damage. Immediately report any damage to carrier. Check contents of package to ensure that the following items are included:

1. Machine
2. Batteries(x2)
3. Squeegee assembly
4. Scrubber-dryer User Manual
5. Electric Battery Charger Manual (if equipped)
6. connecting wire for battery and charger (if equipped)
7. brush or pad driver (if equipped)

BATTERY DISASSEMBLY AND INSTALLATION

1. Switch off the main switch.
2. Remove the recovery tank as shown in the relevant paragraph.
3. Unscrew the bolt from batteries, then remove or change.
4. Install the batteries on the machine according to the diagram below.
5. Install the recovery tank.

**WARNING**

Do not connect⁺ to+, or - to-, when disassembly or install the batteries. It is very dangerous.

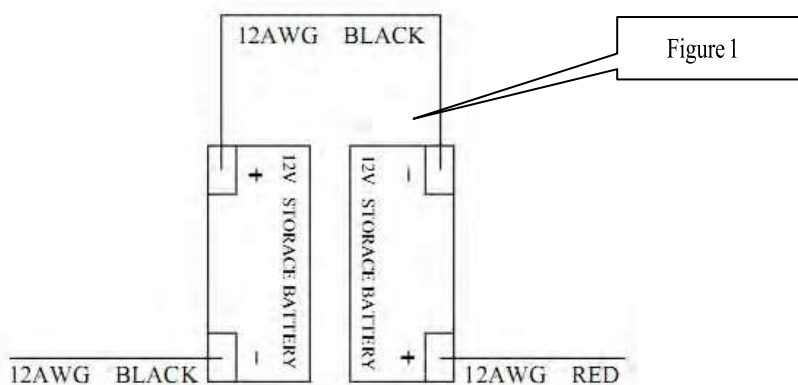
**Battery charging**

Charge the batteries (see the procedure in Maintenance chapter).

MACHINE SET UP**Pre-operation checks**

1. Sweep or dust mop the surface to be cleaned.
2. Check that squeegee is properly installed.
3. Lower the squeegee with the lever.
4. Check battery are fully charged.(see BATTERY CHARGIN)
5. Check that brush/pad is properly installed.

Brush/Pad driver installation and disassembly

	<p>NOTE</p> <p><i>Only install manually. If auto-installation, it will wear brush hub. Make sure that the tanks are empty before disassembling the brush.</i></p>
---	--

1. Turn off the machine.
2. Lay down the machine in this position as indicated in the figure2, Pull up the lift lever to raise the squeegee up.
3. Mount the brush or pad driver onto the drive wheel hub and then rotate counterclockwise until it locks, as indicated in the figure 3.
4. To remove the brush/pad, rotate the brush/pad clock wise until it is released from drive wheel hub.

	<p>WARNING</p> <p><i>Do not turn on the machine in this position as below. The brush/pad could disengage and cause injury.</i></p>
---	---

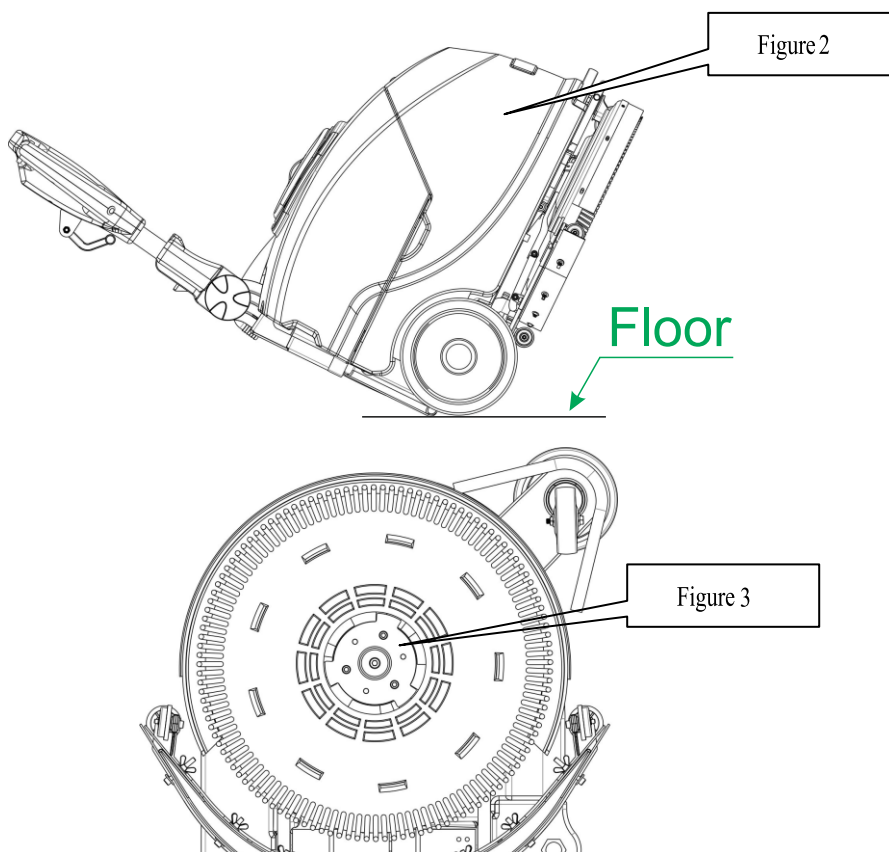

Squeegee installation

1. Turn off the machine.
2. Pull down the squeegee lift lever to put down the squeegee on the “working” position.
3. Lay down the machine in this position as indicated in the figure2.
4. Loosen the two knobs on the squeegee and slide the squeegee into the slots of squeegee brackets
Tighten the knobs securely (unscrew the knobs, if disassembly).
5. To replace the front/rear squeegee unscrew the thumb nut.

Solution tank filling

	<p>NOTE <i>The machine can be filled with a with pipe or bucket. Do not remove the Solution filter while filling.</i></p>
---	--

1. Fill water into solution tank from the inlet through pipe or bucket
2. Do not fill the solution tank completely, leave a few centimeters from the edge.
3. The water temperature must not exceed 40°C.

	<p>CAUTION! <i>Use only low-foam and non-flammable detergents, intended for automatic scrubber applications</i></p>
---	--

Solution tank draining

	<p>NOTE Solution tank should be drained and cleaned after each scrubber operation is completed.</p>
---	--

1. Unscrew the drain cap on the bottom of solution tank. The solution/water will flow freely into a bucket or floor drain.
2. Rinse the solution tank with clean water after every use. This will help prevent chemical build up and clogging of the solution lines
3. Screw up the drain cap.

Recovery tank draining

	<p>NOTE Recovery tank should be drained and cleaned after each scrubber operation is completed.</p>
---	--

1. Turn the latch off the recovery tank, take off the recovery tank from machine by grasping two grooves of tank. Open the lid and overturn the recovery tank to drain the dirty water into a container, or unscrew the drain cap to let water pipe out to a bucket.
2. Clean and Rinse the recovery tank with clean water after every use.
3. Re-place the recovery tank on the machine and turn the latch to lock the tank..



MACHINE OPERATION

1. Set the handle to a comfortable height by pressing level.
2. Lower the squeegee onto the floor by pulling down the lift mechanism.

3. Turn on the main switch.
4. Turn on the brush motor switch and the solution switch , the indicate light will be on.
5. Turn on the vacuum motor switch , the indicate light will be on.
6. If necessary, adjust the water flow by turn the ball valve manually
7. Pull one or both operating triggers , and then brush will start to spin, solution will begin to flow.
Move the machine and start cleaning,

NOTE

If the battery indicator light is green, the machine can be used. If it is yellow or red, the batteries must be charged.

	<p>CAUTION! <i>Before lifting the brush, turn it off by pressing the switch.</i></p>
	<p>CAUTION! <i>When cleaning excessively aggressive floors or others this could cause the machine do not work, brush motor and vacuum indicators on the Control panel flashing simultaneously. It means the machine being overloaded. Please turn off all the switches on the Control panel .</i></p>
	<p>CAUTION! <i>Do not use the machine with discharged batteries to avoid damaging the batteries and reducing the battery life.</i></p>

AFTER USING THE MACHINE

After scrubbing, please proceed with below actions before leaving the machine:

1. Remove the brush/pad-holder.
2. Empty the tanks as shown in the previous parsagraph.
3. Perform the daily maintenance procedures
4. Store the machine in a clean and dry place, with the brush/pad-holder and the squeegee
5. If storing in an area which may reach freezing temperatures, be sure to drain all fluids from the machine prior to storage. any damage caused by freezing temperatures will not be covered by the warranty.

MACHINE NOT BEING USED FOR LONG PERIODS

If the machine is not going to be used for more than 30days, please proceed with below actions:

1. Perform the procedures shown in 'After Using the Machine paragraph'.
2. Disconnect the battery connector.

MAINTENANCE

The lifespan of the machine and its maximum operating safety are ensured by correct and regular maintenance. The following chart provides the scheduled maintenance. The intervals shown may vary according to particular working conditions, which will be defined by the person in charge of the maintenance.

	<p>WARNING <i>Maintenance procedures must be performed with the machine switched off and the batteries/battery charger cable disconnected. Moreover, carefully read the instruction in the Safety chapter.</i></p>
---	---

All scheduled or extraordinary maintenance procedures must be performed by qualified personnel, or by

an authorized Service Center.

This Manual describes only the easier and most common maintenance procedures.

For other maintenance procedures shown in the Scheduled Maintenance Table, refer to the Service Manual that can be consulted at any Service Center.



SCHEDULED MAINTENANCE TABLE



Procedure	Daily, after using the machine	Weekly	Every six months	yearly
Battery charging				
Squeegee cleaning				
Brush cleaning				
Tank and vacuum grid with float cleaning, the cover gasket check				
Squeegee blade check and replacement				
Solution filter cleaning				
Out-water pipe filter cleaning				
Screw and nut tightening check			(1)	
rotary parts getting lubricant			(1)	
Brush/Pad-holder motor carbon brush check or replacement				(2)
Vacuum system motor carbon brush check or replacement				(2)

(1) And after the first 8 working hours.

(2) This maintenance procedure must be performed by an authorized viper Service Center.

BATTERY CHARGING



	<p>NOTE <i>Charge the batteries when the yellow or red indicator ,or at the end of every working cycle.</i></p>
	<p>CAUTION! <i>Keeping the batteries charged make their life last longer.</i></p>
	<p>CAUTION! <i>If the machine is not equipped with on-board battery charger, choose an external battery charger suitable for the type of batteries installed.</i></p>

	<p>WARNING! Please use approved charger to charge the battery</p>
	<p>WARNING! Pay careful attention when charging WET batteries as there may be battery fluid leakages. The battery fluid is corrosive. If it comes in contact with skin or eyes, rinse thoroughly with water and consult a physician.</p>

1. Place charger and machine in a well ventilated area.
2. Turn machine off.
3. Take away the recovery tank , Exposing battery compartment.
4. Plug the charging cable to the grounded wall outlet (100v~240v).
5. Connect the charging cable to the machine socket.
6. The charging indicator light turn on means It is in charging, green light means battery charging is completed.
7. Upon the completion of charging, first unplug the charging cable from the wall outlet and then disconnect from machine.
8. Replace the recovery tank.

	<p>NOTE For further information about the operation of the battery charger, see the relevant paragraph.</p>
---	--

SQUEEGEE CLEANING

	<p>NOTE The squeegee must be clean and its blades must be in good condition in order to getting a good drying performance.</p>
	<p>CAUTION! It is advisable to wear protective gloves when cleaning the squeegee because there may be sharp debris.</p>

SQUEEGEE BLADE CHECK AND REPLACEMENT

1. Take off the squeegee as shown in the previous paragraph.
2. Check to see if the edge of the front/rear blades are cracked or split, if necessary replace them with new.
3. Unscrew six the thumb nut to get off the blades.
4. Check the front/rear blades for integrity, cut and tears. If they are not adequate, overturn or replace them.
5. Install the squeegee in the reverse order of removal.

BRUSH /PAD DRIVER CLEANING

	<p>CAUTION! <i>It is advisable to wear protective gloves when cleaning the brush/pad because there may be sharp debris.</i></p>
---	--

1. Remove the brush/pad.
2. Clean and wash the brush/pad with water and detergent.
3. Check the brush bristles for integrity and wearing status; if necessary, replace the brush.
4. Check the pad for wearing status; if necessary, replace the pad driver.

TANK/VACUUM GRID WITH FLOAT CLEANING AND COVER GASKET CHECK

	<p>CAUTION! <i>It is advisable to wear protective gloves when cleaning the tank and vacuum/suction assembly because there may be sharp debris.</i></p>
---	---

1. Move the machine to the appointed disposal area.
2. Turn off the main switch.
3. Take off the recovery tank , clean and rinse both solution/recovery tank, and drain out.
4. Take off all vacuum kits, gasket, filter, clean and re-install.
5. Check the recovery tank lids gasket ring and the vacuum rubber connector between two tanks are integrity or not..

	<p>NOTE The gasket ring of recovery tank and the rubber connector between two tanks create vacuum in the tank. If necessary, replace them.</p>
---	---